

OPERATING MANUAL

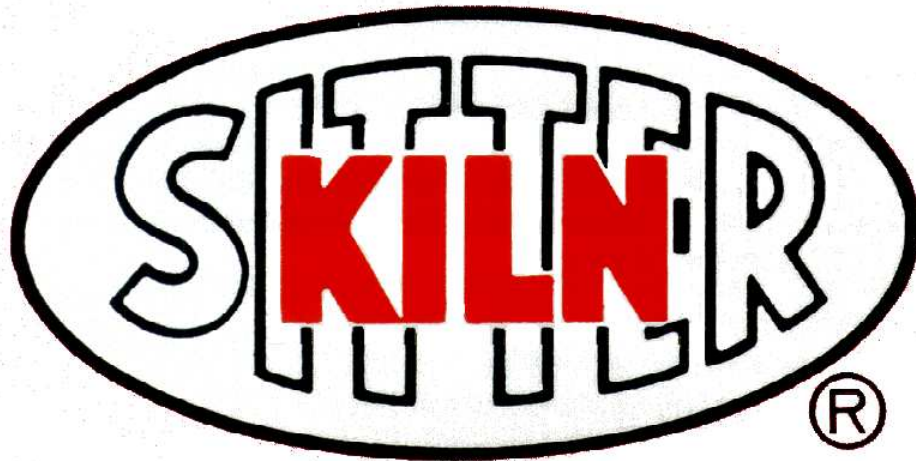

MODELS LT-3 & LT-3K

CAUTION

The KILN-SITTER® control is a valuable tool to help you achieve consistent result when firing your kiln. It is engineered to give you years of trouble-free performance when it is kept in proper adjustment and maintained as described in the KILN-SITTER® Operating Manual.

The KILN-SITTER® control is **NOT** intended to perform as a fail-safe shut-off device and your kiln should **NOT** be left unattended beyond the estimated firing time. An uncontrollable accident, such as greenware falling against the end of the KILN-SITTER® tube, might cause an over-firing which could damage your kiln. In this event, the operator should be in attendance to shut off the kiln manually.

WARNING

DO NOT FIRE YOUR KILN OVER OR NEAR FLAMMABLE MATERIAL (i.e. wood floor, carpeting, etc.) SEE KILN SITTER Limited Warranty.

KILN SITTER LIMITED WARRANTY

The KILN SITTER is guaranteed to be free of defects in material and workmanship for one (1) full year from date of original purchase. Any part that proves to be defective, under normal operating conditions, will be replaced when returned prepaid to W.P. Dawson, Inc., 399 Thor Place, Brea, California 92621. Returned part must be accompanied by written proof of purchase and description of defect (and operating problem it caused) within two (2) weeks of occurrence.

This warranty expressly does not extend to the following:

1. Tube assembly and other KILN SITTER parts damaged in an overfiring determined by W.P. Dawson, Inc. not to be a defect in material or workmanship.
2. Damage to the kiln and kiln contents resulting from an overfiring.
3. KILN SITTER parts damaged during salt or reduction firing.
4. Damage to KILN SITTER when operated beyond the listed electrical rating.
5. Damage caused when kiln is installed over or near flammable material.

The liability of W.P. Dawson, Inc. is limited to the purchase price of the KILN SITTER.

KILN-SITTER OPERATING MANUAL

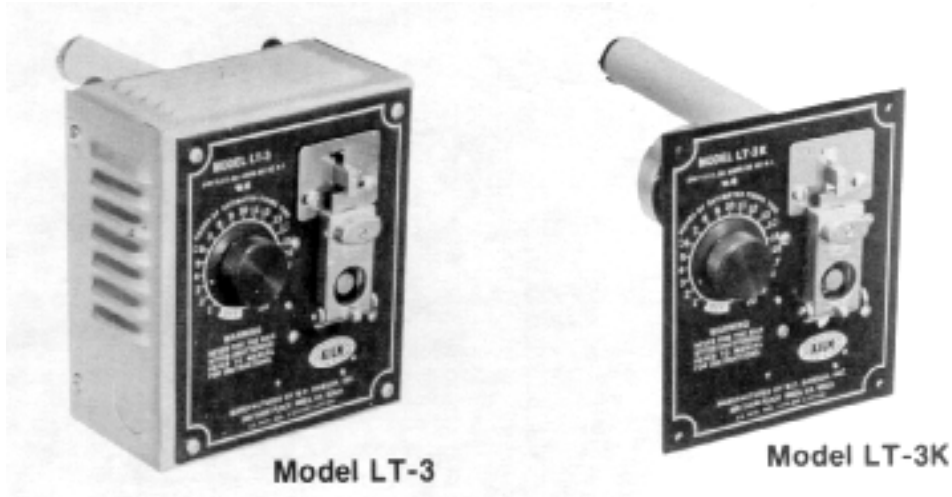

Thank you for choosing the KILN-SITTER® control on your ceramic kiln. You, like ceramists the world over, can now enjoy your hobby more because the KILN-SITTER® is "watching" your kiln while you do other things. Years of trouble free firing are yours to enjoy if you will take the time to carefully read the kiln operating instructions and KILN-SITTER® manual.

The KILN-SITTER® is a mechanical control that fires your kiln by the TIME and TEMPERATURE method of heat treatment using a small cone or bar. The cone or bar, after being exposed to the proper time and temperature, softens and bends to a pre-determined angle, shutting off the kiln. Your choice of cone or bar, proper KILN-SITTER® adjustment and tube position determine when the kiln will shut off.

The Models LT-3 and LT-3K also have an electrically driven mechanism, set by the operator prior to firing, which will trip the lock and shut off the kiln if the normal cone or bar operation does not perform properly. This back-up device is used only as a safety feature and should not be used to override the function of the cone or bar.

The KILN-SITTER® requires very little attention but may need an occasional adjustment check and replacement of critical parts such as the tube assembly, cone supports or sensing rod. Frequency of replacement depends on the type of firing being done, type of clay used, venting and the moisture content of the pieces being fired.

To insure that your KILN-SITTER® is properly adjusted, we suggest you follow the instructions on the following pages and test fire your **empty** kiln with the KILN-SITTER® before you do anything else.

KILN-SITTER PARTS IDENTIFICATION

MODEL LT-3

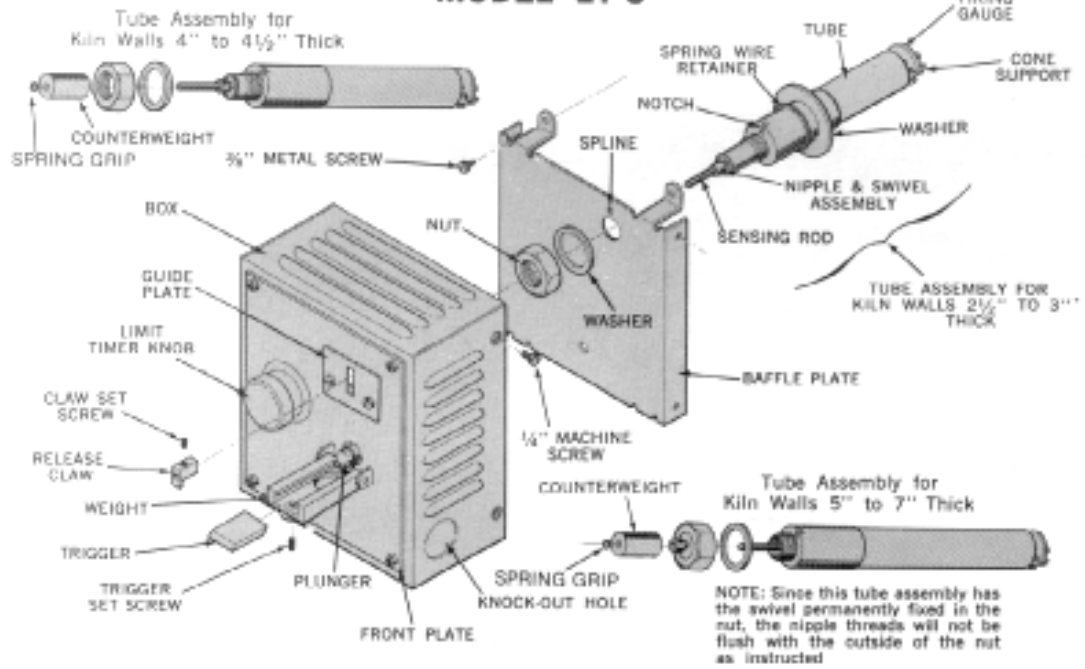

MODEL LT-3K

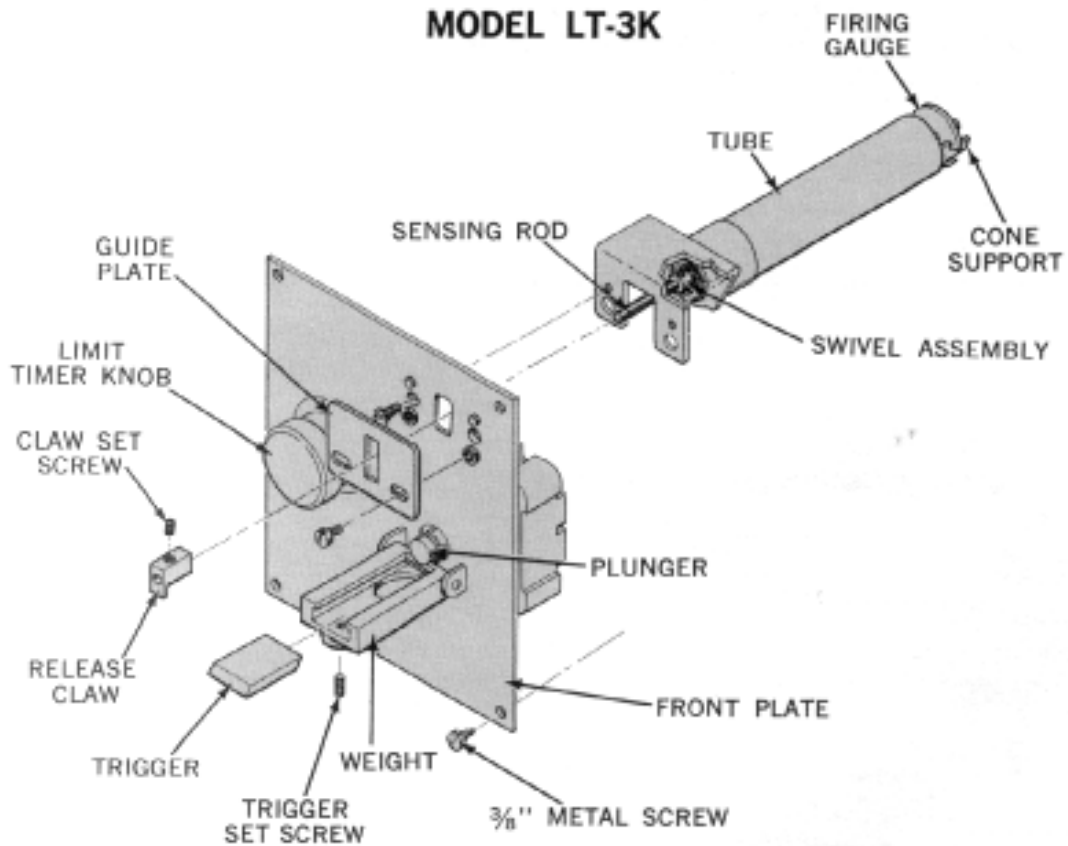

Adjustments

Even if your KILN-SITTER® was adjusted at the factory, it could have been jarred out of adjustment during shipment or delivery. Let's first be sure the KILN-SITTER® is in proper adjustment before using.

Here are some simple adjustment checks for you to make before firing your kiln. We urge you to make them carefully and repeat this check every 30 firings during its lifetime.

1. TURN ALL SWITCHES OFF

2. INSTALL FIRING GAUGE

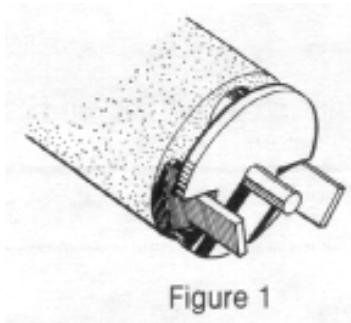

Normally the firing gauge is in position when your kiln is shipped from the factory (held by a rubber band at the end of the KILN-SITTER® tube.) If it has been removed, it should now be replaced over the sensing rod and cone supports, as shown in Figure .

CAUTION : Remove firing gauge before operating kiln.

3. CHECK POSITION OF RELEASE CLAW AND WEIGHT TRIGGER

- a. With the firing gauge in position, swing the weight up against the guide plate. Pull the claw forward (against the slight play in the swivel/pivot assembly) and check for a 1/16th-inch clearance between the inside tip of the claw and the face of the trigger as shown in Figure 2. The set screw on top of the claw may be loosened if the adjustment of the claw position is necessary. Retighten the set screw firmly.

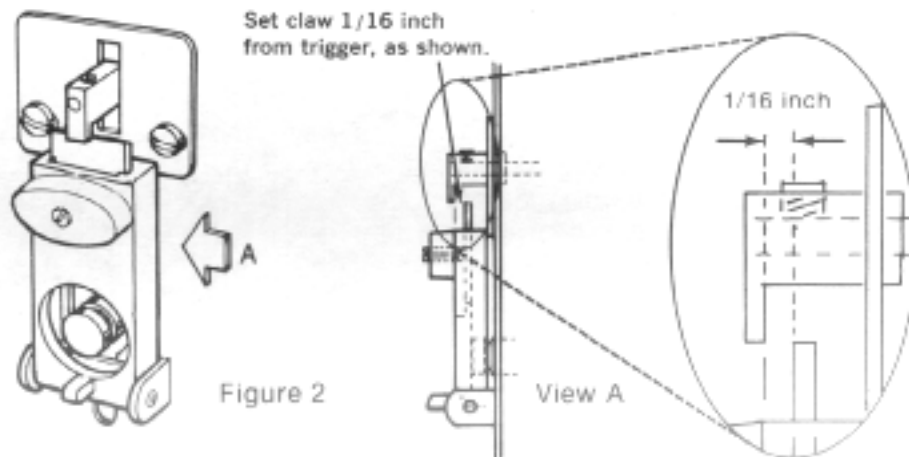

Set trigger to just clear claw, as shown.

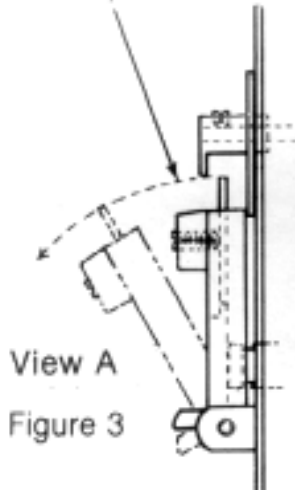

b. When the weight swings forward, the trigger should just clear the tip of the claw, as shown in Figure 3. The setscrew in front of the weight may be loosened to raise or lower the trigger, as shown in Figure 4. The setscrew must be firmly tightened or the force of repeated falling of the weight may cause the trigger to creep out of adjustment.

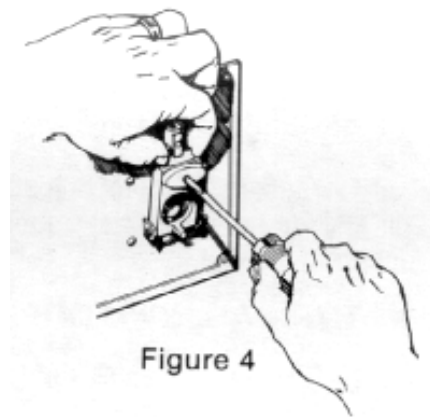

Check your kiln with a level to make sure it is not standing on an uneven floor. If this should occur, your weight may not fall when released.

WARNING: Do not fire your kiln over or near FLAMMABLE material (i.e. wood floor, carpeting, etc.)

4. CHECK THE TRAVEL OF THE SENSING ROD

THE FIRING GAUGE SHOULD NOW BE REMOVED BUT KEPT FOR FUTURE PERIODIC ADJUSTMENTS. The sensing rod is now free to travel vertically within the tube cavity. It should travel freely in the center of the cavity without touching the sides at any point, as shown in Figures 5 and 6.

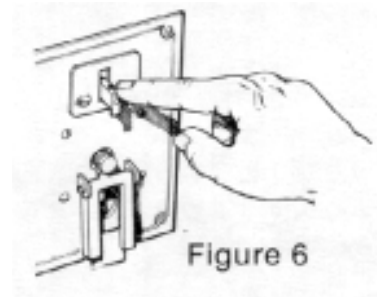
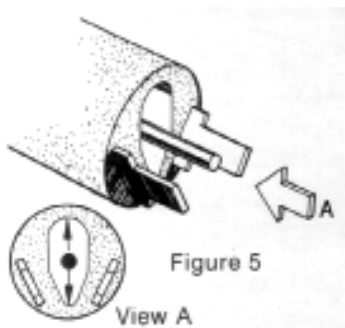

If necessary, the sensing rod may be centered by loosening the two guide plate screws in front of the KILN-SITTER® and moving the guide plate right or left as required, as shown in Figure 7. Be sure the guide plate screws are firmly tightened.

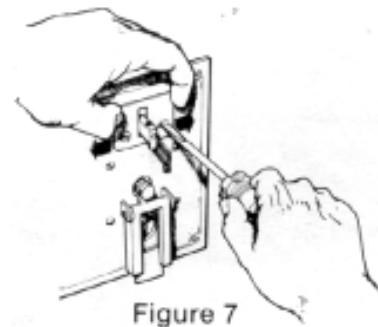

When these adjustments have been made, you are ready to test fire.

TEST FIRING

Firing tests are made with the kiln **empty**. Two small size cones, which mature at a relatively low temperature, are provided with the KILN-SITTER® for test firing. This allows you to complete the test firing in the shortest possible time. Additional cones are available from your dealer.

1. FIRING GAUGE HAS BEEN REMOVED.

2. APPLY KILN WASH

(A small nail polish bottle with brush is ideal for this purpose.) Mix Hi-Fire kiln wash with water to a creamy solution. Apply a THIN coat to the cone supports and the sensing rod where they will come in contact with the cone. Do not apply kiln wash to the cone or to the end of the porcelain tube. Allow wash to dry thoroughly. **Do not allow kiln wash to accumulate.**

3. RAISE WEIGHT UP AGAINST GUIDE PLATE.

4. PRESS CLAW DOWN LIGHTLY UNTIL IT ENGAGES TRIGGER.

5. INSERT CONE (SEE PAGE 7, Item 7.)

While holding the claw down over the trigger, carefully place one of the test cones flat on the cone supports with the inside edge of the number circle even with the outside edge of the cone support. See Figure 8. The cone should be back against the metal step of the cone support with the center of the cone parallel with the end of the tube.

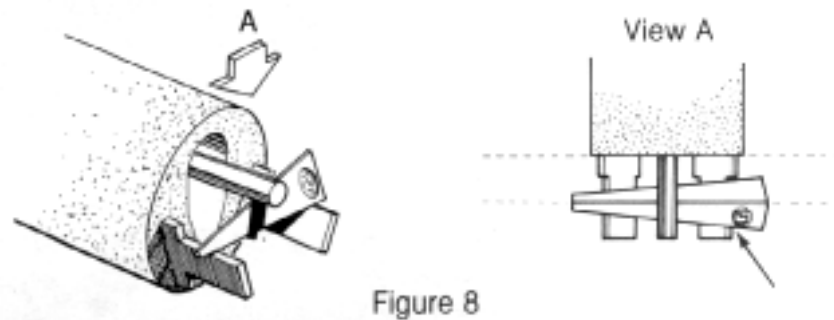

Figure 8

CAUTION: Since the softening and bending of the cone shuts off your kiln, its correct positioning is important for proper firing. IF THE CONE IS DISLODGED BY ACCIDENT OR ALLOWED TO COME IN CONTACT WITH THE PORCELAIN TUBE, AND OVER-FIRING MAY RESULT WHICH COULD CAUSE SERIOUS DAMAGE TO YOUR KILN

The cone now holds the claw engaged so that the weight is supported and your hands are free. You are now ready to close the kiln and begin the test fire.

6. **TURN ALL SWITCHES OFF.**
7. **THE LIMIT TIMER IS USED DURING THE TEST FIRING. TURN THE TIMER KNOB CLOCKWISE TO NUMBER 1-1/2 OR 2 ON THE SCALE.**
8. **INSERT A FINBER INTO THE HOLE IN THE WEIGHT AND PUSH FIRMLY IN ON THE PLUNGER UNTIL IT LOCKS.**
9. **FIRE THE KILN BY USING THE REGULAR KILN SWITCHES, AS INSTRUCTED BY THE KILN MANUFACTURER. (For purposes of test firing, when the kiln is empty, the highest temperature setting may be used.)**

In approximately one hour the KILN-SITTER® weight will drop, shutting off the kiln.

When the kiln is cool enough to handle you may open it and inspect the cone. If all adjustments have been made correctly, the cone on the KILN-SITTER® will be bent to an approximate 90-degree angle shape similar to the illustration in Figure 9. However, if it is bent similar to the "over-fired" illustration, reduce the kiln switch settings. This will increase the firing time, reduce the rate of climb and allow the cone to mature properly.

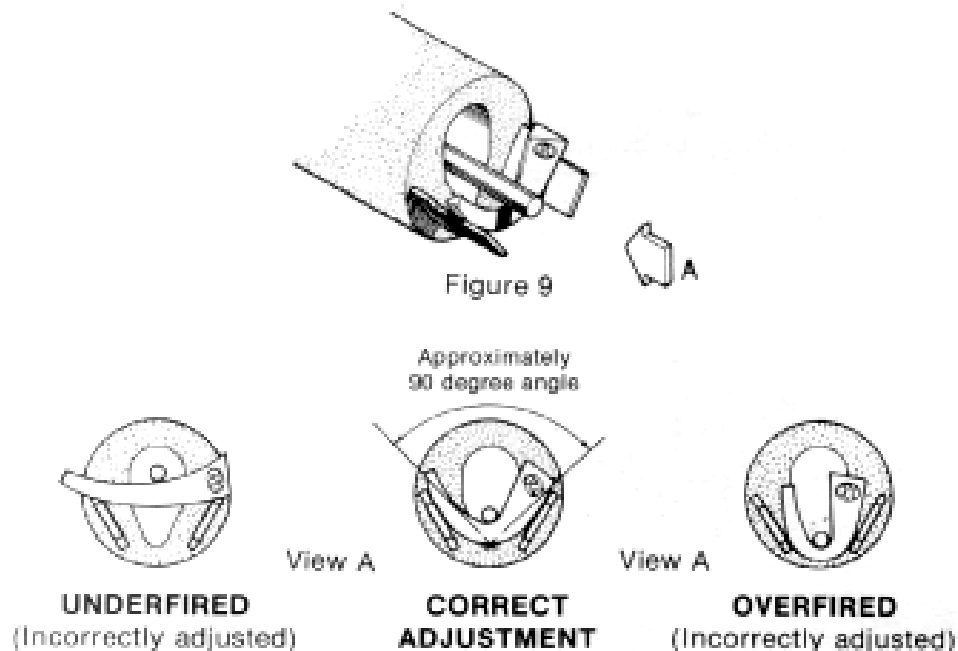

The best way to verify that your load is reaching a certain firing treatment is by using witness cones. These are valuable and inexpensive instruments that reliably measure actual firing performance. Witness cones are optional but we recommend their use during test firing and also periodically during normal operations, as a check for consistent firing performance. For information on witness cones, refer to page 9.

You are now ready to begin normal firing operations.

NORMAL OPERATION

It is the responsibility of the KILN-SITTER® user to become familiar with the proper operation and adjustment of the KILN-SITTER®. If the simple steps and precautions, outlined in this manual, are followed with care, it will serve you as a valuable and reliable instrument for greater success and enjoyment in your ceramic firing.

When you have assured that the KILN-SITTER® is in proper adjustment by test firing, as described in that section, you are ready for normal firing operation.

1. CHECK THE SENSING ROD

Before each firing check the sensing rod for free and centered travel. **In spite of precautions, the swivel/pivot of the tube assembly can become corroded or contaminated and alter the normal shut off.** If the sensing rod moves sluggishly, does not fall freely or you have inconsistent firings, immediately replace the tube assembly. Refer to pages 12 through 14.

2. TURN ALL KILN SWITCHES OFF

The life of the KILN-SITTER® switch will be increased if kiln switches are off before engaging the KILN-SITTER®

3. APPLY KILN WASH

Apply a THIN coat of Hi-Fire kiln wash to the cone supports and sensing rod where they will come in contact with the cone. Allow the kiln wash to dry thoroughly. We suggest two pair of supports be available. This allows you to prepare a clean pair while the other pair is being used in the firing.

4. STACK WARE IN THE KILN

When loading your kiln, care should be taken to keep the KILN-SITTER® tube, cone supports, and cone or bar visible from above at all times. If the tube is covered from view, the cone or bar could accidentally be dislodged from its proper position without being noticed and cause a malfunction of the KILN-SITTER® shut-off. Shelves and ware should be positioned at least an inch above or below the KILN-SITTER® tube so that the normal shut-off function will not be obstructed.

5. RAISE THE WEIGHT UP AGAINST THE GUIDE PLATE

6. PRESS THE CLAW DOWN LIGHTLY UNTIL IT ENGAGES THE TRIGGER

7. INSERT THE CONE (Small size cones or bars are used on KILN-SITTER®)

While holding the claw down over the trigger, carefully place the cone or bar, selected for your firing, flat on the metal cone supports with the inside edge of the number circle even with the outside edge of the cone supports. See Figure 8. The cone or bar should be against the metal step with the center of the cone or bar parallel with the end of the tube. Consistent placement of the cone or bar in this manner will lead to consistent firing control. The cone or bar now holds the claw engaged so that the weight is supported and your hands are free.

8. CHECK THE POSITION OF THE CONE OR BAR

As a last step before closing the kiln, always check to see that the cone or bar is in its proper position and free of obstructions. AN IMPROPERLY PLACED CONE OR BAR COULD CAUSE AN OVERFIRING AND DAMAGE YOUR KILN AND WARE.

9. CLOSE THE KILN All switches are off at this point.

10. SET THE LIMIT TIMER KNOB (1/4 to 1/2-hr beyond firing time)

The timing knob will not allow the plunger assembly to engage when in the OFF position. Always set the timer prior to switch engagement (pushing on the plunger.)

How to use the Limit Timer

The limit timer is a safety shut-off device to protect your kiln from over-firing in case the KILN-SITTER® fails, through some malfunction, to shut off the kiln when the pyrometric cone or bar has matured. The numbers on the limit timer control knob indicate 20-hours of firing time. If your firing requires a longer period, the knob may be reset during firing for this additional time. Since the function of the limit timer is to override the actual firing time, it should always be set for a longer period than the estimated firing time. After you have become familiar with the firing of your particular kiln, you can set the limit time as low as 1/4-hour longer than the estimated firing time. Until you have reached that degree of familiarity, it is safer to set the limit timer 1/2-hour longer than the estimated firing time.

The limit timer may also be used as a timing device to aid you while you are learning to estimate firing times. For example, if the timer knob is set at "7" before firing, and the indicator is on "1" when firing is completed, you know that the elapsed time was 6-hours.

Caution: The timing knob should never be set beyond 20-hours. If the timing motor should be inoperative, such action could jam the switch assembly, possibly causing an over-firing.

11. REMOVE THE TOP PEEP HOLE PLUG

Venting of the kiln for the entire firing period will add years of life to your KILN-SITTER® tube assembly. (On large kilns also remove the bottom peephole plug.)

12. INSERT A FINGER INTO THE HOLE IN THE WEIGHT AND PUSH FIRMLY IN ON THE PLUNGER UNTIL IT LOCKS.

13. WEIGHT CLEARANCE

The area outside the kiln should be clear of obstructions so the free fall of the weight is not impeded.

14. FIRE THE KILN BY USING THE REGULAR KILN SWITCHES, AS INSTRUCTED BY THE KILN MANUFACTURER.

DO NOT LEAVE THE KILN UNATTENDED BEYOND THE ESTIMATED FIRING TIME. An uncontrollable accident, such as greenware falling against the end of the KILN-SITTER® tube may cause an over-firing, which could damage your kiln. Should this occur, the operator should be in attendance to shut of the kiln manually.

WITNESS CONES

A pyrometric cone is a slender pyramid composed of materials compounded in selected combinations to make a cone that will react to time and temperature in the same way as the ware you place in your kiln. Because different clays and glazes require different heat treatments to mature properly, pyrometric cones are made in a series of cone numbers so that one is available to properly control the firing of the clay or glaze you are using.

Even though small cones are always used on the KILN-SITTER®, *large size* cones are recommended as witness cones when test firing your kiln and KILN-SITTER®, and periodically during normal firing. This will help you determine whether firing shut-off is just right ... too soon (temperature too low) ... or too late (temperature too high.) During the test firing you will also learn your kiln's "personality" or its heat distribution.

For this test firing you will need a plaque, which is a porous clay base designed to hold three large size cones at an angle of 8-degrees from vertical. See Figure 12. (Note: self-supporting cones are also available.)

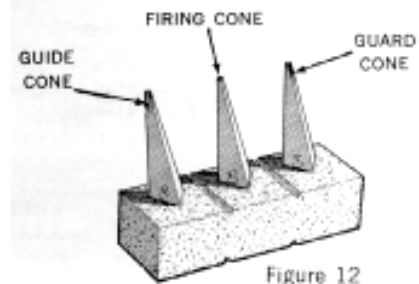

Figure 12

A cone, one number cooler than the firing cone, is placed on one side. This is called the GUIDE CONE. It matures at a temperature approximately 30-degrees lower than the firing cone. When it bends, it serves as a warning that shut-off time is near. See Figure 13.

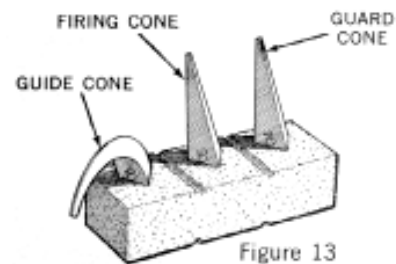

Figure 13

The cone number we wish to fire to is placed in the middle. It is called the FIRING CONE. It is the same cone number as the cone on your KILN-SITTER®. When it bends over with the tip close to, but not quite touching, the base, you know that the desired heat treatment has been reached. See Figure 14.

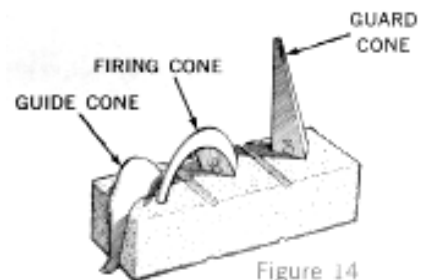

Figure 14

On the other side is a cone that is one number hotter than the firing cone, It is called the GUARD CONE. If it bends at all, you know that the kiln has fired beyond the preselected point.

The plaque of three cones should be placed on a shelf close to the level of the KILN-SITTER® tube. However, because a shelf supported by stilts is not completely stable, the height of the shelf should be one inch above or one inch below the tube. This will prevent a possible jamming of the normal KILN-SITTER® shut-off function should the shelf expand or tilt in the direction of the tube.

After test firing, during normal operations, you may wish to place a plaque on EACH shelf level, since temperatures vary at different levels within a kiln. When setting your kiln shelves, follow the kiln manufacturer's instructions. The spacing between shelves will depend upon the objects you wish to fire. This spacing, as well as the size and weight of your ware, has an affect on heat distribution.

After firing is completed, you will see some differences in the appearance of the test plaques. If for example your firing was made with two or more shelves, the lower shelf will usually show less bending of the cones than the plaque located on a shelf near the top of the kiln. This range of heat treatment normally will be within the range recommended for your materials.

The shelf locations, and amount of material placed on each shelf, and the switching sequence, will have some affect upon the heat distribution in your kiln. But as long as each plaque of cones show cone values within the range recommended for your material, you can be sure it is receiving proper heat treatment.

Now fire the kiln in the manner recommended by the kiln manufacturer. Use the proper switch sequence and follow venting procedures for necessary air circulation.

If witness cones, after the first test fire, appear similar to those illustrated in Figure 14, you will know that the KILN-SITTER® is in proper adjustment. But make a second test firing exactly as you did before. This will serve as a double check and indicate the consistency of firing performance.

If the witness FIRING cone is UNBENT, then test fire a second time using a hotter cone on the KILN-SITTER® (one number higher.)

If a second test fire, as recommended above, does not cause proper maturing of the witness cones, as illustrated in Figure 14, then it is recommended that you recheck all adjustments, as described in that section and repeat the two test fires.

MAINTENANCE OF YOUR KILN-SITTER

Your KILN-SITTER® is manufactured from the finest materials available ... selected for strength, durability and resistance to heat and corrosion. However, during the firing operation, moisture and corrosive gasses are created which can, in time, alter the normal shut off function. Below are maintenance procedures and operating recommendations which will keep your KILN-SITTER® doing its job. Careful attention to these instructions will reward you with trouble free firing

NEVER USE LUBRICANTS OF ANY KIND ON THE KILN-SITTER®

PERIODIC ADJUSTMENTS

The KILN-SITTER® may get out of adjustment during use and we suggest you repeat an adjustment check every 30 firings as described on Page 3 under "**ADJUSTMENTS**".

VENTING THE KILN

The top peephole should be left open for the entire firing period. This venting will reduce deterioration of the kiln's metal parts and increase the life of the tube assembly. (Larger kilns may need both top and bottom plugs removed.)

CARE OF CONE SUPPORTS

It is important that excess kiln wash not be allowed to accumulate on the supports. We recommend they be cleaned after every firing with a small wire brush. In the event the kiln wash or cone glaze cannot be removed, rotate the supports to the clean side or replace them. We suggest two pair of supports be available. This allows you to prepare a clean pair while the other pair is being used in the firing.

CARE OF THE SWIVEL/PIVOT (Tube Assembly)

The swivel/pivot of the tube assembly is the most sensitive part of the KILN-SITTER® and can become corroded and contaminated during normal firing. This can cause sluggish movement of the sensing rod and alter the shut off of the KILN-SITTER®. We recommend, as good insurance against a mishap, that the guide plate be removed and the swivel/pivot of the tube assembly be examined every 6 to 12 months. The frequency of inspection depends on the type of firing, clay composition and moisture content, and humidity in the area. Evidence of contamination or sluggish movement would indicate immediate replacement of the tube assembly

SENSING ROD

Continued operation at high-fire temperatures will eventually cause the end of the rod to deteriorate or bend. This will, in turn, affect the adjustment of the trigger and claw. If this occurs, the rod must be replaced.

OPERATIONAL TEMPERATURE

The KILN-SITTER® is engineered to withstand kiln temperature up to and including Cone 8. Temperatures higher than this limit will reduce the normal lifetime of the cone supports and sensing rod.

REPLACEMENT OF TUBE ~ MODEL LT-3

Should it become necessary to replace the tube in the Model LT-3 KILN-SITTER®, the following instructions should be followed

CAUTION: BE SURE POWER IS OFF BEFORE PROCEEDING!

1. Refer to PARTS IDENTIFICATION, Model LT-3, on Page 2 for an exploded illustration of Model LT-3 and the names of its parts.
2. Remove the box from the baffle plate by unscrewing the 1/4-inch machine screws on the right and left sides (4 screws.)
3. Remove the baffle plate from the kiln by unscrewing the four 3/8-inch metal screws. The baffle plate with tube assembly attached is now free to be withdrawn from the opening in the kiln wall.
4. Disassemble the old tube from the baffle plate by removing the large nut and washer.

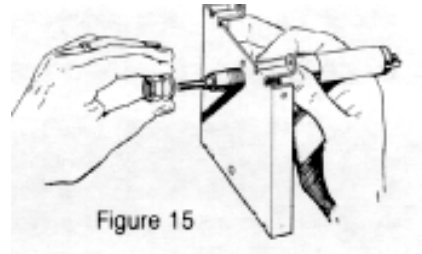

5. Remove the nut and washer from the new tube assembly. Insert the nipple and tube through the hole in the baffle plate, as shown in Figure 15. Replace the washer and nut, but before tightening be sure that the spline protruding from the baffle plate engages in the notch at the top of the tube metal jacket. When the nut is tightened, the end of the nipple threads should be flush with the outer surface of the nut. If necessary, the nipple can be threaded in or out of the jacket to achieve this adjustment. When these things are done, tighten the nut firmly.

6. As shown in Figure 16, the rear end of the sensing rod should be even with or slightly behind the ends of the cone supports. The setscrew in the swivel assembly may be loosened if adjustment is necessary. Be sure the setscrew is firmly tightened.

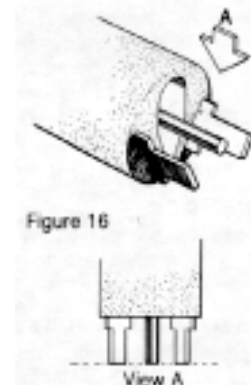

7. Place the spring wire retainer over the tube and onto the metal jacket, then the washer. After replacing the baffle

plate onto the kiln wall, push the washer and spring wire retainer forward against the kiln wall.

- Counterweights are on all tube assemblies except the 2-1/2 inch, 3-inch and K-long or short tube assemblies. These weights provide a counterbalance that controls the weight of the sensing rod as it bears on the cone during firing. In this way, firing performance is equalized between sensing rods of differing lengths.

The counterweight must be positioned up tight against the swivel nipple, held in place by the sliding spring grip. See Figure 17.

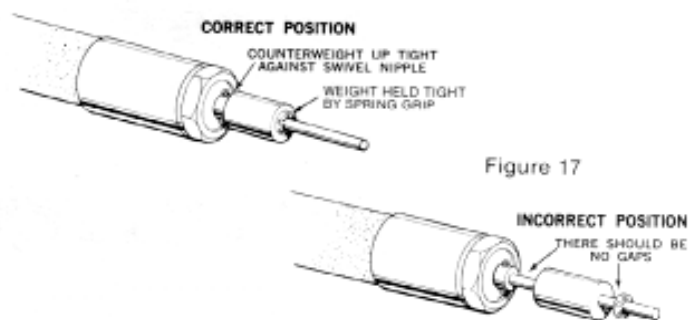

- Replace the box assembly. Adjust and test fire the newly installed tube, as described in the front part of the manual.

REPLACEMENT OF TUBE - MODEL LT-3K

Should it become necessary to replace the tube in the Model LT-3K KILN-SITTER®, the following instructions should be followed.

CAUTION: BE SURE POWER IS OFF BEFORE PROCEEDING!

1. Refer to PARTS IDENTIFICATION, Model LT-3K on Page 2 for an exploded illustration of Model LT-3K and the names of its parts.
2. The tube is attached to the front plate by two flat-headed screws that are hidden behind the metal guide plate. It is therefore necessary to first remove the guide plate by removing its two screws.
3. Remove the two flat-headed screws, which were hidden behind the guide plate. This frees the tube from the front plate.
4. Free the front plate from the kiln wiring box by removing its four screws ... top and bottom.
5. The plate can now be pulled forward as far as the wiring will allow. Usually this will provide enough room to remove the old tube and install its replacement. If the wiring does not provide sufficient clearance for the tube, it may be necessary to remove the entire wiring gutter from the kiln.
6. Attach the new replacement tube, Refer to the exploded diagram on the inside back cover of this booklet for proper positioning of the tube.
7. Replace the front plate onto the kiln wiring box.
8. Adjust and test fire the newly installed tube as described in the front part of the manual.

KILN-SITTER® PARTS LIST MODELS LT-3 and LT-3K

<u>Part No</u>	<u>Description</u>
1.	Gauge, Firing
2.	Cone Supports (pair)
3.	Sensing Rod (advise model and kiln wall thickness)
4.	Tube Assy (advise model and kiln wall thickness)
	2-1/2 inch 5-inch
	3-inch 5-1/2 inch
	4-inch 6-inch
	4-1/2 inch 7-inch
5.	Washer
6.	Brass Nipple (nipple only)
6a.	Brass Nipple with Swivel (short)
6b.	Brass Nipple with Swivel (long)
8.	Washer, Tube Nut
9.	Nut, Tube (nut only)
9a.	Nut Tube, with Swivel
15.	Plunger Assembly
15a.	Plunger Assembly, Delrin Button
16a.	Claw and Set Screw
16b.	Guide Plate (plate only)
18.	Screw, 6-32 x 1/4
19.	Set Screw, 6-32 x 1/8
24.	Paper Washer Center Post
26.	Spring, Center Post
29.	Set Screw, 8-32 x 3/8
30.	Pivot Pin
33.	Retainer, Lock Spring
34.	Screw, 4-40 x 1/4
35.	Retainer, Locking Cam or Lock
36.	Screw, Lock Spring 4-40 x 1/8
37.	Screw, #6 x 3/8 Self-Tapping
38.	Screw, #8 x 3/8 Self-Tapping
40.	Box, Large Opening (P-10 and LT-4)
42.	Heat Baffle, Off Center Hole (P-10 and LT-4)
43.	Retainer, Spring Ring
44.	Counterweight, Tube (P and LT-3) 4-Inch
45.	Counterweight, Tube (P and LT-3) 5-Inch
46.	Counterweight, Tube (P and LT-3) 4-1/2 and 5-1/2 Inch
47.	Counterweight, Tube (P and LT-3) 6-Inch
48.	Counterweight, Tube (P and LT-3) 7-Inch
56.	Screw, Motor Mounting 6-32 x 1/4
58.	Locking Cam
59.	Spring, Locking Cam
62.	Set Screw, Knob 10-32 x 1/2
64.	Knob, 9/16-Inch Thick (knob only)
67.	Motor, Limit Timer (220v/60Hz/20Hr)
67a.	Motor, Limit Timer (120v/60Hz/20Hr)
67b.	Motor, Limit Timer (220v/50Hz/20Hr)
68.	Spring Grip
70.	Tube Assy, Short K & LT-3K (6" from end of porcelain to end of bracket)
70a.	Tube Assy, Short K & LT-3K (7" from end of porcelain to end of bracket)
71.	Screw, Center Post 6-32 x 5/16
72.	Lock Washer, Center Post Screw
75.	Center Post
75a.	Center Post Assy (Items 24, 26, 71, 72 and 75)
76.	Nut, Switch Mounting 4-40 Radio
78.	Stand-Off Bushing, Switch Mounting
80.	Screw, Flat Head 6-32 x 5/16
81.	Screw, Switch Mounting 4-40 x 1-1/2 Oval Head
85.	Shim, Motor Mounting
91.	Front Plate Assy, LT-3 20Hr (Items 29, 30, 102, 103, less 16a and 16b)
92.	Front Plate Assy, LT-3K 20Hr (Items 29, 30, 102, 103, less 16a and 16b)
93.	Nylon Washer, Switch Mounting
94.	Switch Block (block only)
95.	Switch Block, with Contacts, less Center Post and Spring
95a.	Switch Block Assy, with Contacts, Center Post and Spring
95b.	Switch Block Assy, #95a with Item 15 Plunger Assembly
96.	Rear Contact, Modified
97.	Nylon Washer, Contact
98.	Nut, Contact
99.	Screw, 10-32 x 3/8
102.	Trigger, 1/16 x 3/4 x 1-1/8
103.	Weight, 1/16 x 3/4 Cavity (weight only)
310.	Bracket, Tube

KILN-SITTER MODEL LT-3

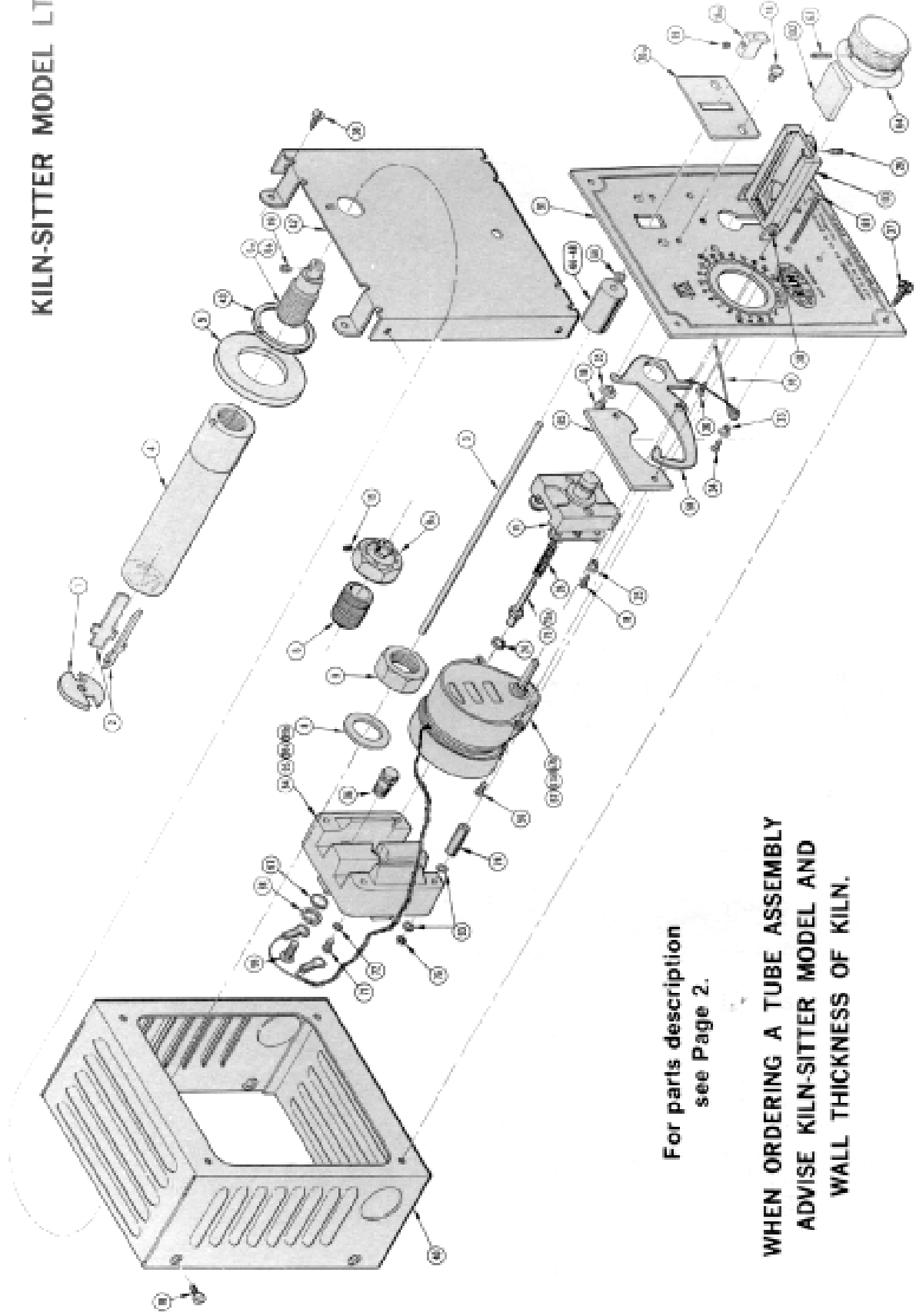

For parts description
see Page 2.

**WHEN ORDERING A TUBE ASSEMBLY
ADVISE KILN-SITTER MODEL AND
WALL THICKNESS OF KILN.**



U.S. Patent Nos. 2,675,600, 3,287,530 
& 4,464,548

TEMPERATURE EQUIVALENTS FOR ORTON STANDARD PYROMETRIC CONES

Cone No.	Large Cones	
	108°F*	270°F*
022	1069°F	1086°F
021	1116	1137
020	1157	1175
019	1234	1261
018	1285	1323
017	1341	1377
016	1407	1458
015	1454	1479
014	1533	1540
013	1596	1566
011	1591	1623
010	1627	1641
09	1629	1641
08	1679	1693
08	1733	1751
07	1783	1803

Cone No.	Large Cones	
	108°F*	270°F*
06	1816°F	1830°F
05	1888	1915
04	1922	1940
03	1987	2014
02	2014	2048
01	2043	2079
1	2077	2109
2	2088	2124
3	2106	2134
4	2134	2185
5	2151	2285
6	2194	2232
7	2219	2264
8	2257	2305
9	2300	2336
10	2345	2381

*Rate of Heating (Example: 108°F rise per hour)

Notes:

- 1) The rates of heating shown at the head of each column of temperature equivalents were maintained during the last several hundred degrees of temperature rise.
- 2) The temperature equivalents are not necessarily those at which cones will deform under firing conditions different from those under which the calibrating determinations were made. For more detailed technical data, please write the Orton Foundation.

W.P. DAWSON, INC.

399 Thor Place
Brea, California 92621

Tel: (714) 529-2813
FAX: (714) 529-3254
email: info@kilnsitter.com
Internet: www.kilnsitter.com